

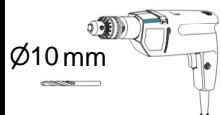

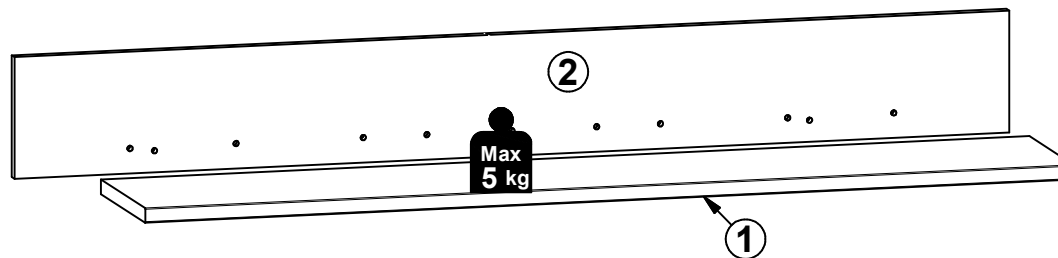

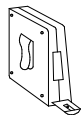

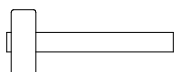

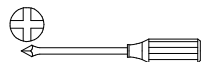
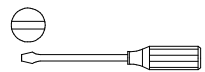





A	B	C (mm)		D
1	S271-3065	1400	250	1/1
2	S271-4501	1500	180	1/1

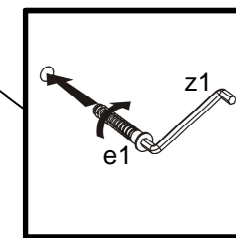
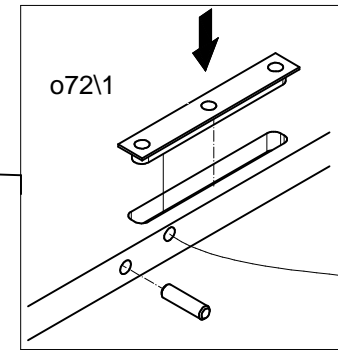
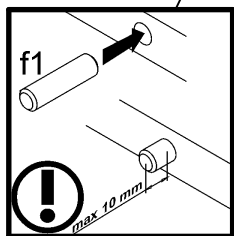
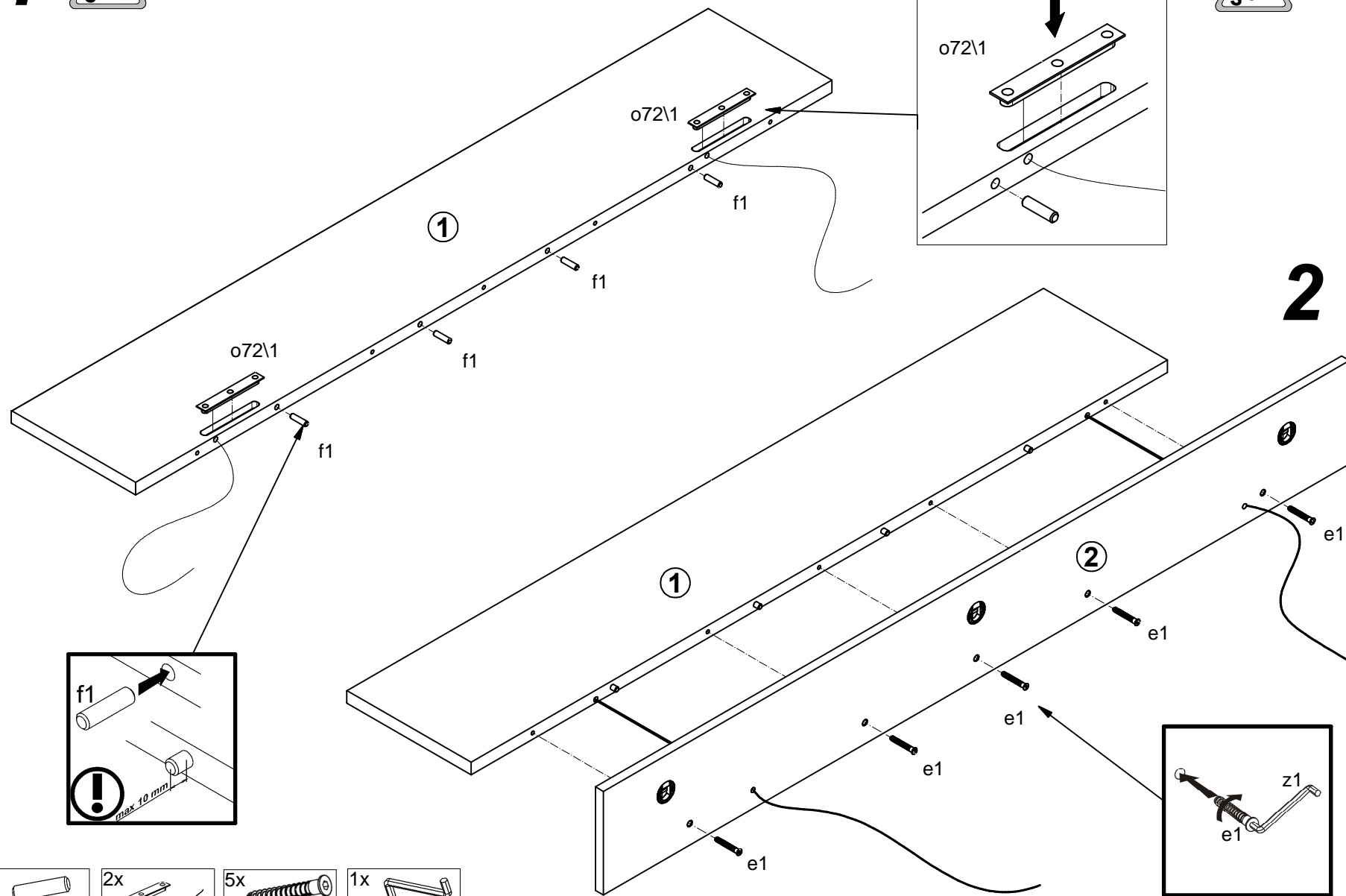

- 5x  e1
Ø7x50 mm
- 4x  f1
Ø8x30 mm
- 3x  f35
Ø10x50 mm
- 2x  o72\1
- 1x  5W
o75\2
- 1x  o80\3
- 3x  p75
Ø6x60 mm
- 6x  o21
silikon
- 1x  z1

1



- 4x  f1
Ø8x30 mm
- 2x  o72\1
- 5x  e1
Ø7x50 mm
- 1x  z1

3

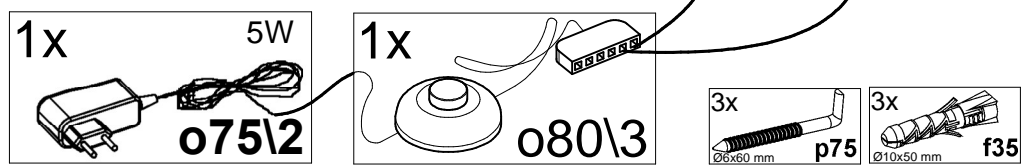
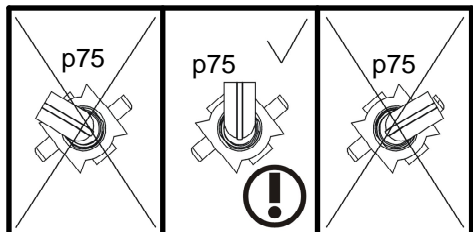
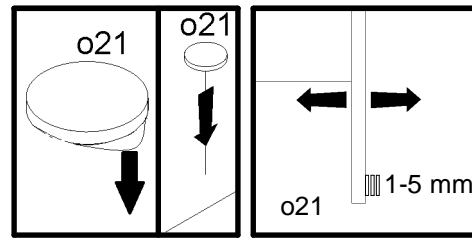
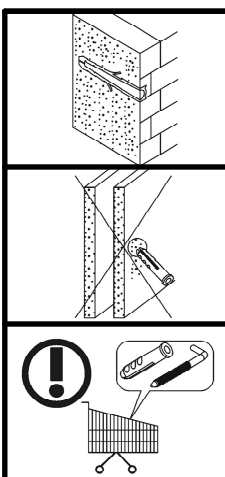
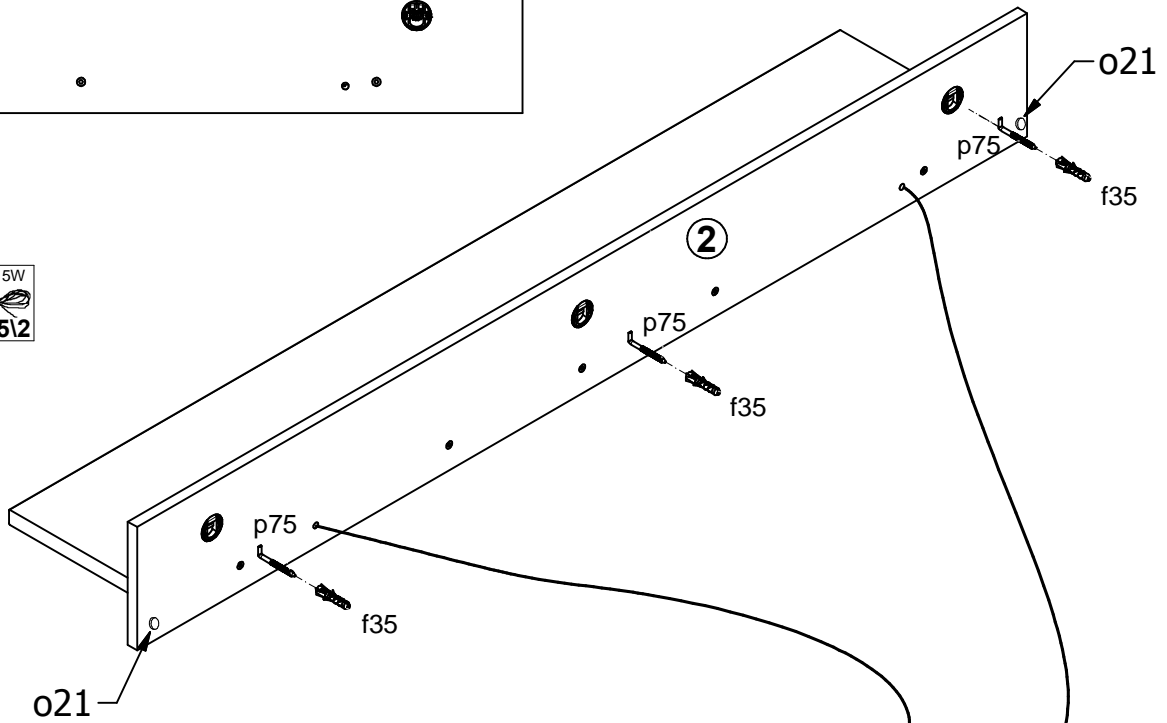
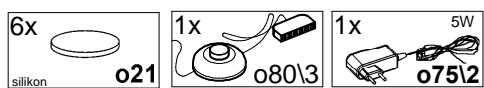
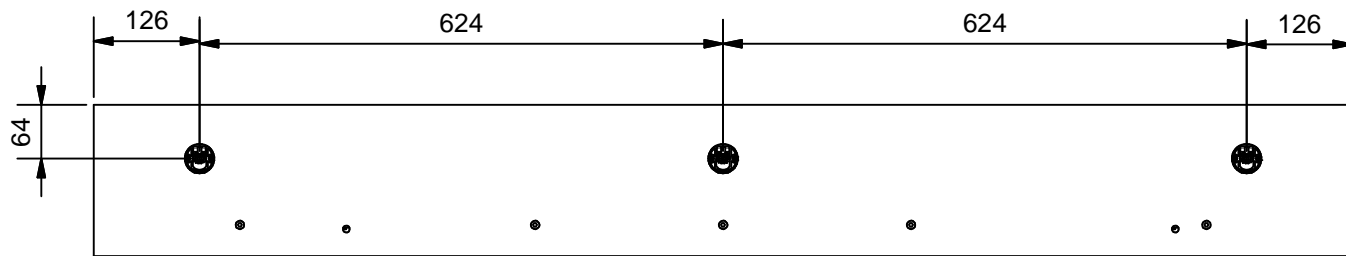
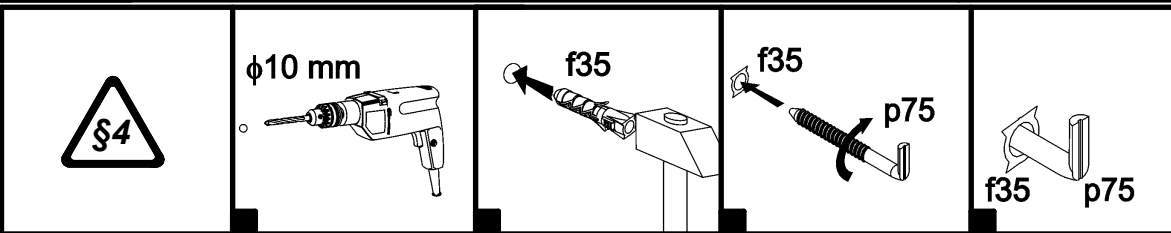

4

